



marantz®

Integrated Amplifier
PM7005

You can print more than one page of a PDF onto a single sheet of paper.

Owner's Manual

[Front panel](#)

[Rear panel](#)

[Remote control
unit](#)

[Index](#)



| | |
|--|----------|
| Accessories | 3 |
| Inserting the batteries | 4 |
| Operating range of the remote control unit | 4 |
| Features | 5 |
| High quality sound | 5 |
| High performance | 6 |
| Easy operation | 6 |
| Part names and functions | 7 |
| Front panel | 7 |
| Rear panel | 10 |
| Remote control unit | 12 |

Connections

| | |
|--|-----------|
| Connecting speakers | 18 |
| Speaker connection | 19 |
| Connecting a playback device | 20 |
| Connecting a recording device | 21 |
| Connecting to a device with digital audio output connectors | 22 |
| Connecting a PC or Mac | 23 |
| Connecting devices with remote control connectors | 24 |
| Performing operations by RC on this unit without visual contact | 24 |
| Remotely connecting Marantz audio devices | 24 |
| Connecting the power cord | 25 |

Playback

| | |
|--|----|
| Turning the power on | 27 |
| Turning speaker output on | 28 |
| Selecting the input source | 28 |
| Adjusting the volume | 28 |
| Turning off the sound temporarily (Muting) | 28 |
| Adjusting the tone | 28 |
| Playing CDs | 29 |
| Connecting and playing back from a computer (USB-DAC) | 30 |
| Connect and playback from a digital device (Coaxial/Optical) | 37 |
| Recording | 37 |

Settings

| | |
|--------------------------------------|-----------|
| Setting the Auto Standby mode | 38 |
| Turning Auto Standby mode off | 38 |
| Turning Auto Standby mode on | 38 |

Tips

| | |
|-----------------|----|
| Tips | 40 |
| Troubleshooting | 41 |

Appendix

| | |
|-----------------------------|-----------|
| D/A converter | 47 |
| Explanation of terms | 47 |
| Specifications | 48 |
| Index | 51 |



Thank you for purchasing this Marantz product.

To ensure proper operation, please read this owner's manual carefully before using the product.

After reading this manual, be sure to keep it for future reference.

Accessories

Check that the following parts are supplied with the product.



Quick Start Guide



CD-ROM (Owner's Manual)



Safety Instructions

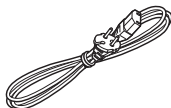

Power cord

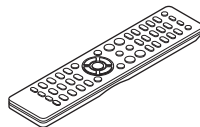

Remote control unit (RC003PMSA)



R03/AAA batteries



Inserting the batteries

- 1 Remove the rear lid in the direction of the arrow and remove it.

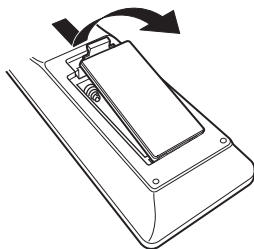

- 2 Insert two batteries correctly into the battery compartment as indicated.

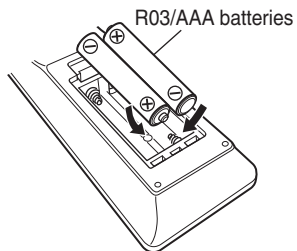

- 3 Put the rear cover back on.

NOTE

- To prevent damage or leakage of battery fluid:
 - Do not use a new battery together with an old one.
 - Do not use two different types of batteries.
- Remove the batteries from the remote control unit if it will not be in use for long periods.
- If the battery fluid should leak, carefully wipe the fluid off the inside of the battery compartment and insert new batteries.

Operating range of the remote control unit

Point the remote control unit at the remote sensor when operating it.

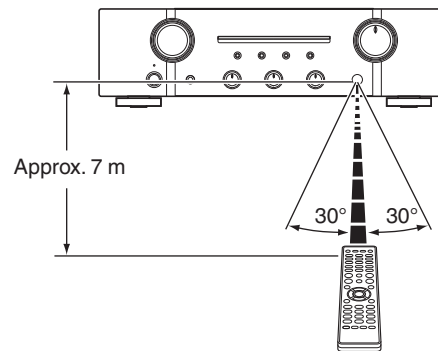

Features

High quality sound

- **All-discrete current-feedback amplifier**

Marantz proprietary current-feedback circuit, using discrete components, is adopted in the pre-amplifier and power amplifier. It is a high-speed amplifier using the latest technology developed for the higher-grade amplifiers.

- **HDAM[®]SA3 Module**

This unit includes the HDAM[®]SA3 which had been developed for highend models. The HDAM[®]SA3 is incorporated into many components, such as the current feedback power amplifier.

- **Short-power-line layout**

For strong momentary current supply, a short power-line layout unifies the power circuit and output stage of the power amplifier section. This layout allows connecting the large-current lines via the shortest route while to arranging the left and right channels symmetrically.

- **CD direct buffer amplifier**

An input buffer amplifier exclusive for CD is mounted near the CD input jacks. This is a high-speed buffer amplifier made with discrete components, which avoids interference between right and left channels and can send the signals to the pre-amplifier with very high fidelity.

- **Block condenser of large capacity**

The unit is equipped with a newly developed 15000 μ F large capacity condenser that incorporates the concepts of high-end devices into the power amplifier power circuit.



High performance

- **Equipped with a USB-DAC function to support DSD file playback**

This unit is equipped with a USB-DAC function that supports DSD signals and 192 kHz/24 bit PCM signals. You can enjoy high-quality audio playback from the D/A converter built in to this unit by inputting PCM signal or DSD signal music files into this unit from a computer via USB connection.

- Install the dedicated driver software onto the computer before use. “Installing the driver software” (📖 p. 30)
- You can use whichever commercially available or downloadable player software you like to playback files on your computer.

- **Can be used as a D/A convertor**

Digital audio signals input from an external device or computer into this unit can be converted and output as analog signals using this unit's D/A converter.

Easy operation

- **Remote control compatible with CD players and network audio players**

The remote control provided with this unit can control Marantz CD players and network audio players in addition to this unit. (📖 p. 13)



Part names and functions

Front panel

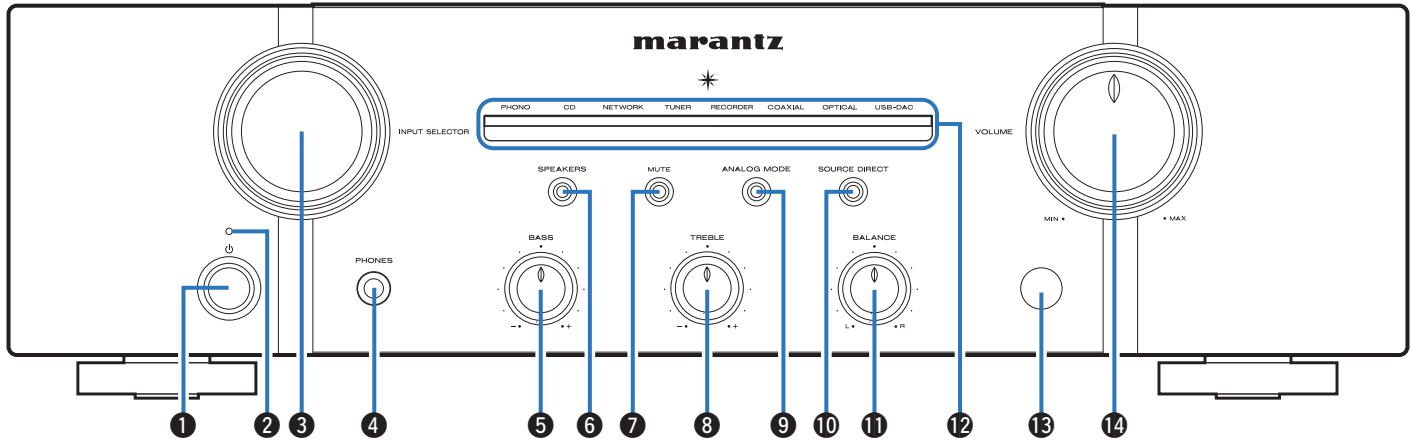

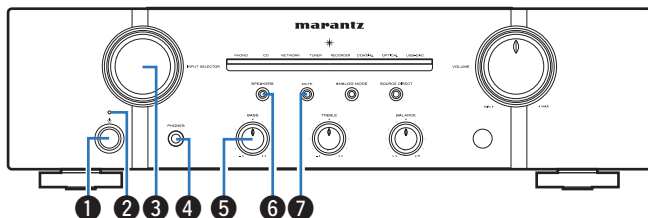

❶ Power operation button (⏻)

This turns the power on/off. (👉 p. 27)

❷ Power indicator

This is lit as follows according to the power status:

- Power on : Off
- Standby : Red
- Power off : Off
- When the protection circuit is activated : Red (blinking)

❸ Input source select knob (INPUT SELECTOR)

This selects the input source. (👉 p. 28)

❹ Headphones jack (PHONES)

Used to connect headphones.

Turn off speaker output when using headphones. (👉 p. 28)

NOTE

To prevent hearing loss, do not raise the volume level excessively when using headphones.

❺ BASS control knob

This setting adjusts the volume level for the bass. (👉 p. 28)

❻ Speaker output button/indicator (SPEAKERS)

This switches speaker output on/off. (👉 p. 28)

Indicates the status of the unit's as follows:

- Speaker output on: Blue
- Speaker output off: Off

❼ MUTE button / indicator

This switches the mute on/off. (👉 p. 28)

- Mute on: Red
- Mute off: Off



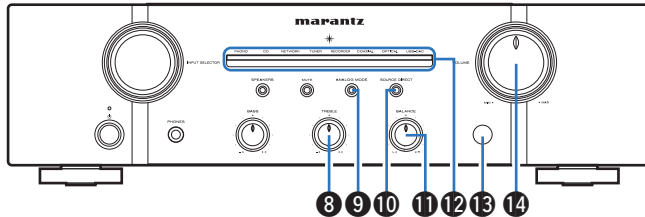

8 TREBLE control knob

This setting adjusts the volume level for the treble. (👉 p. 28)

9 ANALOG MODE button / indicator

This turns the ANALOG MODE on/off. (👉 p. 29)

- ANALOG MODE on: Blue
- ANALOG MODE off: Off

10 SOURCE DIRECT button/indicator

This turns SOURCE DIRECT mode on/off.

(👉 p. 29)

- SOURCE DIRECT mode on: Blue
- SOURCE DIRECT mode off: Off

11 BALANCE control knob

This adjusts the balance of the volume output from the left and right speakers. (👉 p. 28)

12 Input indicator

(👉 p. 28)

13 Remote control sensor

This receives signals from the remote control unit. (👉 p. 4)

14 VOLUME knob

These adjust the volume level. (👉 p. 28)



5, 8 and 11 can be adjusted when 10 is off (SOURCE DIRECT mode is off).



Rear panel

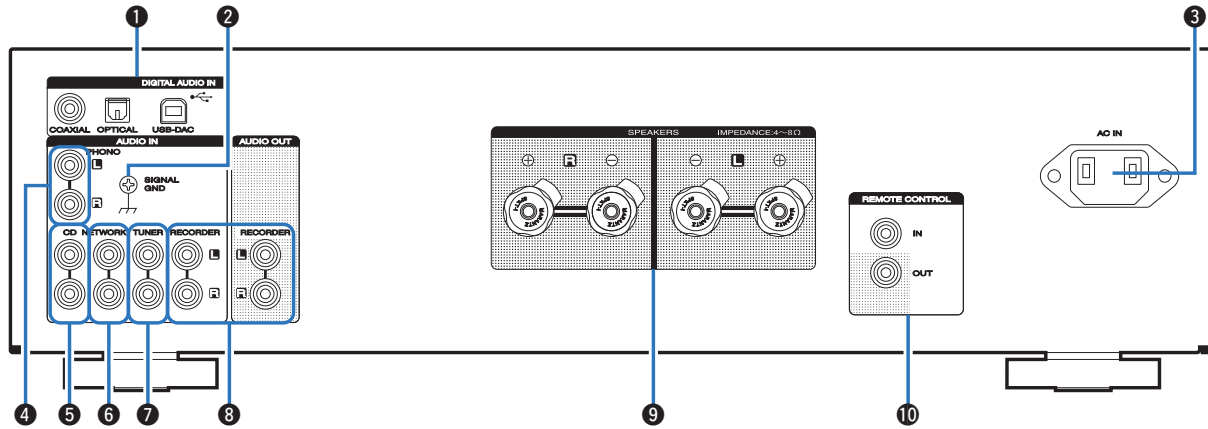

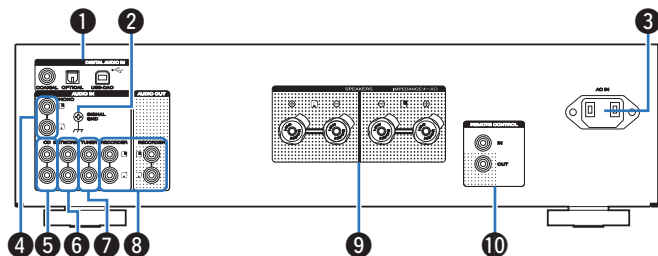

① DIGITAL AUDIO IN connectors

Used to connect devices equipped with digital audio output connectors and PC. (☞ p. 22)

② SIGNAL GND terminal

Used to connect a turntable. (☞ p. 20)

③ AC inlet (AC IN)

Used to connect the power cord. (☞ p. 25)

④ Turntable input connectors (PHONO)

Used to connect a turntable. (☞ p. 20)

⑤ CD input connectors

Used to connect a CD player. (☞ p. 20)

⑥ Network audio player input connectors (NETWORK)

Used to connect a network audio player. (☞ p. 20)

⑦ Tuner input connectors (TUNER)

Used to connect a tuner. (☞ p. 20)

⑧ Recorder input/output connectors (RECORDER)

Used to connect the input/output connector of a recorder. (☞ p. 21)

⑨ Speaker terminals (SPEAKERS)

Used to connect speakers. (☞ p. 18)

⑩ Remote control input/output connectors (REMOTE CONTROL)

Used to connect to a Marantz audio device that is compatible with the remote control function. (☞ p. 24)



Remote control unit

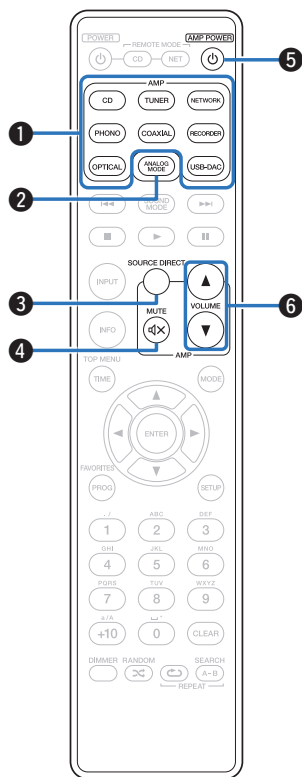

■ Amplifier operations

- 1 **Input source select buttons**
This selects the input source. (☞ p. 28)
- 2 **ANALOG MODE button**
This turns the ANALOG MODE on/off. (☞ p. 29)
- 3 **SOURCE DIRECT button**
This turns SOURCE DIRECT mode on/off. (☞ p. 29)
- 4 **MUTE button (M)**
This mutes the output audio. (☞ p. 28)
- 5 **AMP POWER button (P)**
This turns the power on/off (standby). (☞ p. 27)
- 6 **VOLUME buttons (▲▼)**
These adjust the volume level. (☞ p. 28)



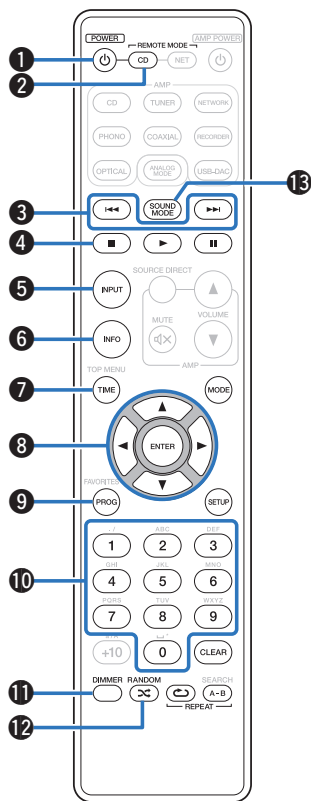

CD player operations

The supplied remote control can be used to control a Marantz CD player in addition to this unit. To operate a Marantz CD player, press the REMOTE MODE CD button to switch the remote control to the CD player operation mode.

- REMOTE MODE CD button lights for approximately two seconds.

- 1 POWER button (⏻)
- 2 Remote mode select button (REMOTE MODE CD)
- 3 Skip buttons (⏮, ⏭)
- 4 Stop button (■)
- 5 Input source select button (INPUT)
- 6 Information button (INFO)
- 7 TIME button
- 8 Cursor buttons (⬆, ⬇, ⬅, ➡)
- 9 Program button (PROG)
- 10 Number buttons (0 - 9)
- 11 DIMMER button
- 12 RANDOM button (⚡)
- 13 SOUND MODE button



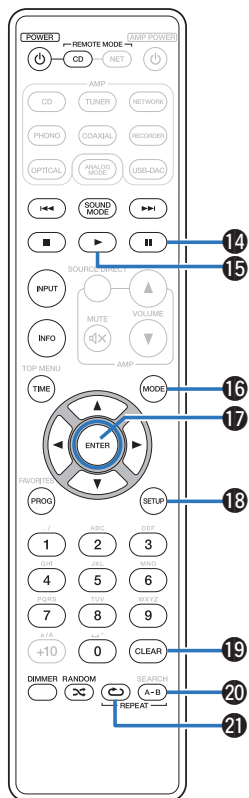

14 Pause button (II)

15 Play button (▶)

16 Playback mode switching button (MODE)

17 ENTER button

18 SETUP button

19 CLEAR button

20 REPEAT A-B button

21 REPEAT button (↺)



The amplifier can be operated with the amplifier operation buttons even when the remote control operation mode is set to CD.



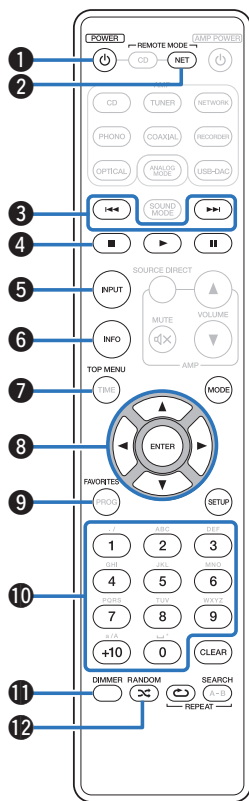

Network audio player operations

The remote control provided with this unit can control a network audio player in addition to this unit. To operate a Marantz network audio player, press the REMOTE MODE NET button to switch the remote control to the network audio player operation mode.

- REMOTE MODE NET button lights for approximately two seconds.

- 1 POWER button (⏻)
- 2 Remote mode select button (REMOTE MODE NET)
- 3 Skip buttons (⏮, ⏭)
- 4 Stop button (■)
- 5 Input source select button (INPUT)
- 6 Information button (INFO)
- 7 TOP MENU button
- 8 Cursor buttons (⬆, ⬇, ⬅, ➡)
- 9 FAVORITES button
- 10 Number buttons (0 – 9, +10)
- 11 DIMMER button
- 12 RANDOM button (∞)



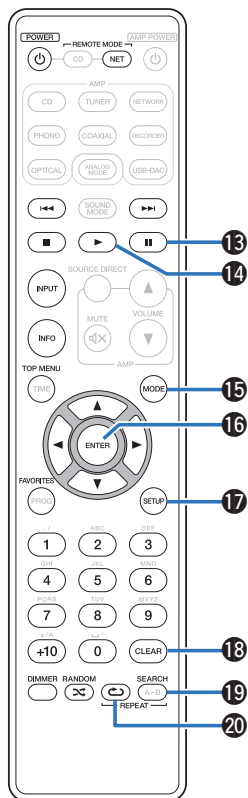

13 Pause button (||)

14 Play button (▶)

15 Playback mode switching button (MODE)

16 ENTER button

17 SETUP button

18 CLEAR button

19 SEARCH button

20 REPEAT button (↺)



The amplifier can be operated with the amplifier operation buttons even when the remote control mode is NET.



■ Contents

| | |
|---|----|
| Connecting speakers | 18 |
| Connecting a playback device | 20 |
| Connecting a recording device | 21 |
| Connecting to a device with digital audio output connectors | 22 |
| Connecting a PC or Mac | 23 |
| Connecting devices with remote control connectors | 24 |
| Connecting the power cord | 25 |

NOTE

- Do not plug in the power cord until all connections have been completed.
- Do not bundle power cords together with connection cables. Doing so can result in humming or noise.

■ Cables used for connections

Provide necessary cables according to the devices you want to connect.

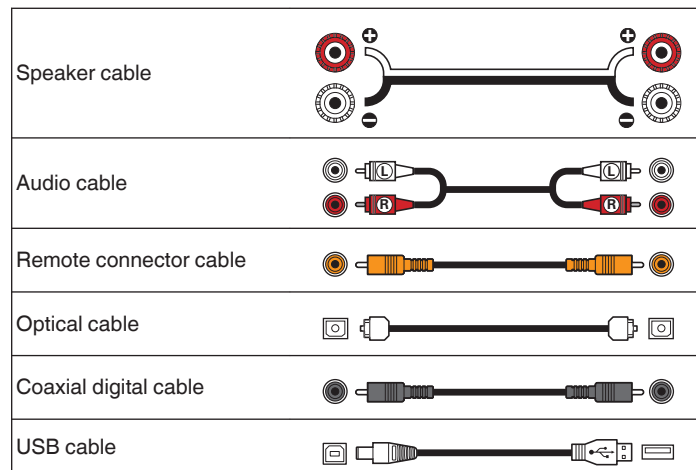

Connecting speakers

NOTE

- Disconnect this unit's power plug from the power outlet before connecting the speakers.
- Connect so that the speaker cable core wires do not protrude from the speaker terminal. The protection circuit may be activated if the core wires touch the rear panel or if the + and - sides touch each other. ("Protection circuit" (☞ p. 47))
- Never touch the speaker terminals while the power cord is connected. Doing so could result in electric shock.
- Use speakers with impedance of 4 - 8 Ω /ohms.

■ Connecting the speaker cables

Carefully check the left (L) and right (R) channels and + (red) and - (white) polarities on the speakers being connected to this unit, and be sure to connect the channels and polarities correctly.

- 1 Peel off about 10 mm of sheathing from the tip of the speaker cable, then either twist the core wire tightly or terminate it.



- 2 Turn the speaker terminal counterclockwise to loosen it.



- 3 Insert the speaker cable's core wire to all the way into the speaker terminal.



- 4 Turn the speaker terminal clockwise to tighten it.

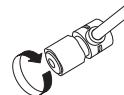

Spade lug connector



Speaker connection

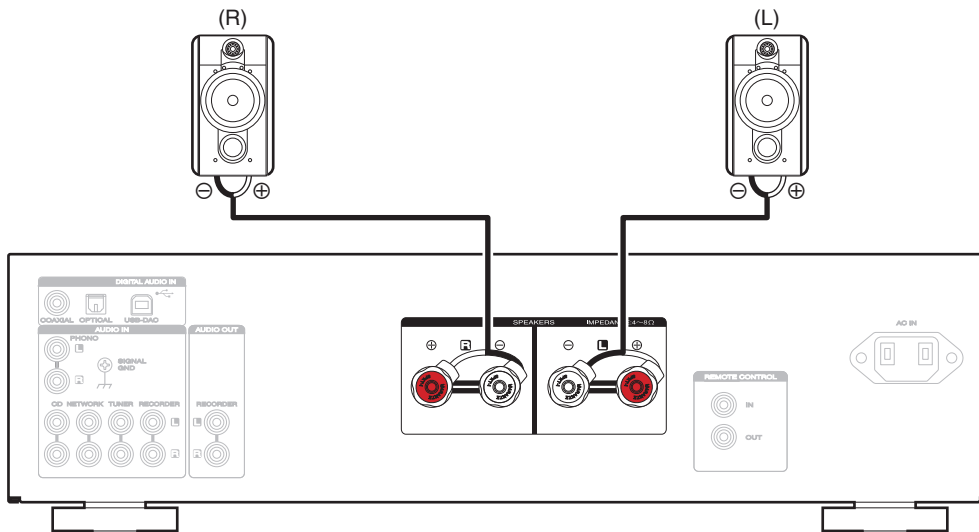

Connecting a playback device

You can connect turntables, tuners, CD players and network audio players to this unit.

This unit is compatible with turntables equipped with a moving magnet (MM) phono cartridge. When you connect to a turntable with a low output moving coil (MC) cartridge, use a commercially available MC head amp or a step-up transformer.

If you set this unit's input source to "PHONO" and you accidentally increase the volume without having a turntable connected, you may hear a hum noise from the speakers.

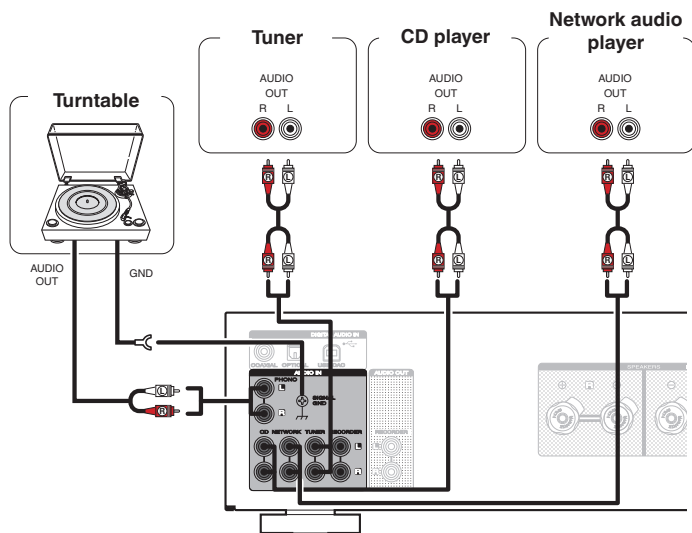

NOTE

The earth terminal (SIGNAL GND) of this unit is not for safety grounding purposes. If this terminal is connected when there is a lot of noise, the noise can be reduced. Note that depending on the turntable, connecting the ground line may have the reverse effect of increasing noise. In this case, it is not necessary to connect the ground line.



Connecting a recording device

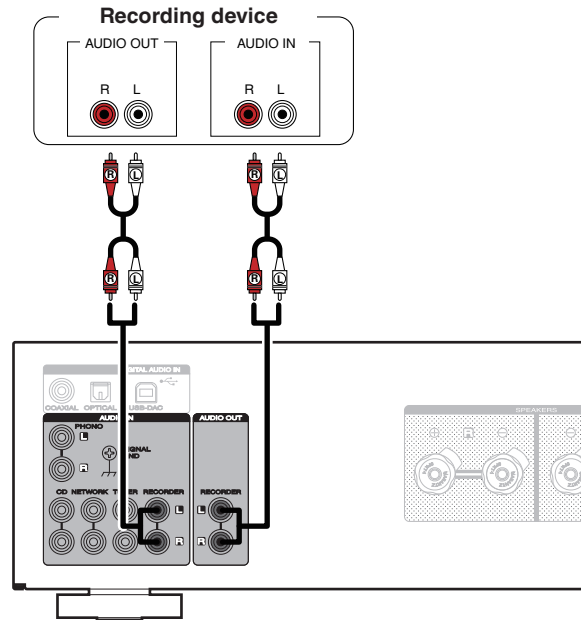

NOTE

Never insert the short-circuiting pin plug into the recording output connectors (AUDIO OUT RECORDER). Doing so could result in damage.



Connecting to a device with digital audio output connectors

Use this connection to input digital audio signals to this unit, and convert the signals for playback using the D/A converter of this unit. (📖 p. 30)

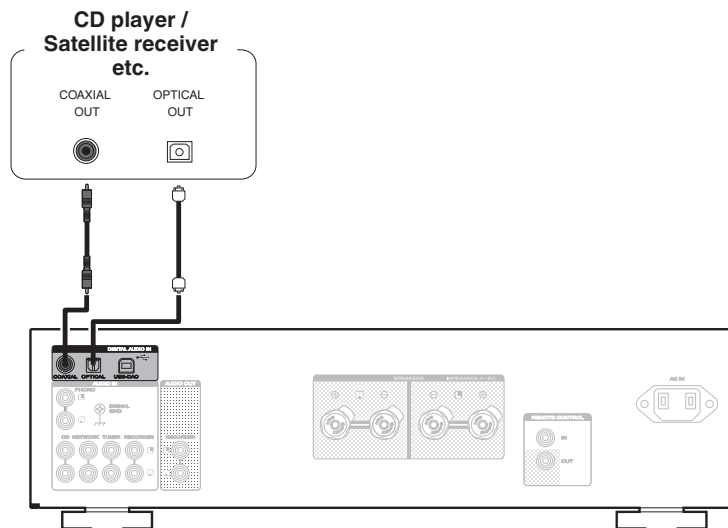

NOTE

- Linear PCM signals with a sampling frequency of 32 kHz, 44.1 kHz, 48 kHz, 64 kHz, 88.2 kHz, 96 kHz, 176.4 kHz, or 192 kHz can be input into this device.
- Do not input non-PCM signals, such as DTS and AAC. This causes noise and could damage the speakers.



Connecting a PC or Mac

By connecting a computer to the USB-DAC port on the rear panel of this unit using a commercially available USB connecting cable, this unit can be used as a D/A converter. (🔗 p. 30)

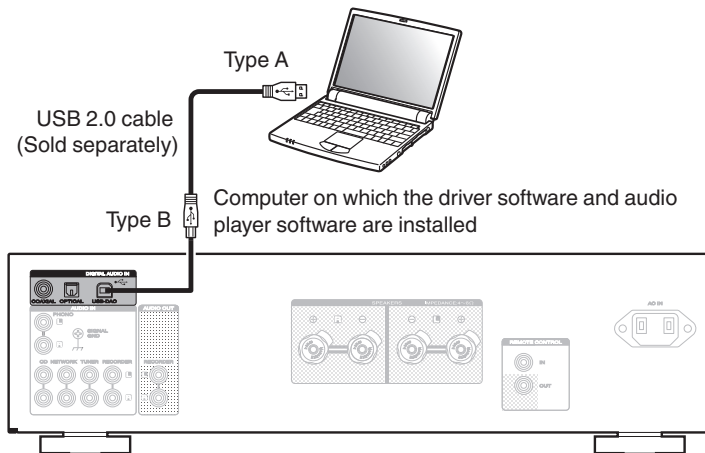

- Install the dedicated driver software on the computer to enable communication between the computer and this unit in order to playback high-resolution sound source (DSD signal or 192 kHz/24 bit PCM signal) audio available on the internet. (🔗 p. 30)
- Download the driver software from the PM7005 page of the Marantz website.

NOTE

Use a cable that is 3 m or less to connect to the computer.



Connecting devices with remote control connectors

Performing operations by RC on this unit without visual contact

You can connect an external IR receiver to the REMOTE CONTROL connectors to perform operations on this unit with the supplied remote control unit without visual contact. This might be necessary if the unit is hidden in a cupboard or corner, so you can't directly point with the remote control unit to the device.

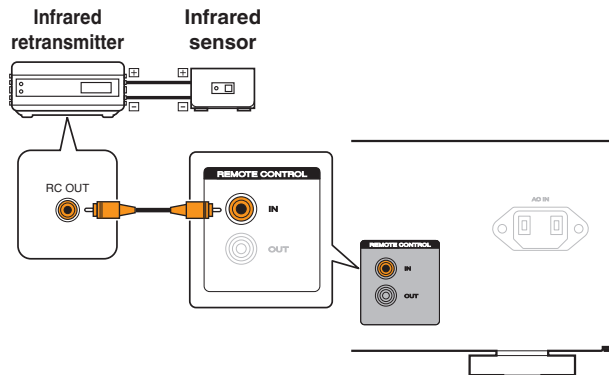

Remotely connecting Marantz audio devices

You can transmit remote control signals simply by connecting a Marantz audio device to the REMOTE CONTROL IN/OUT connectors using the remote connection cable provided with the device.

Set the remote control switch located on the rear panel of the connected audio component to "EXTERNAL" to use this feature.

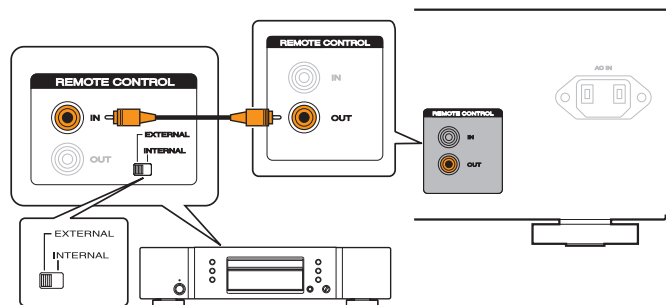

Connecting the power cord

Wait until all connections have been completed before connecting the power cord.

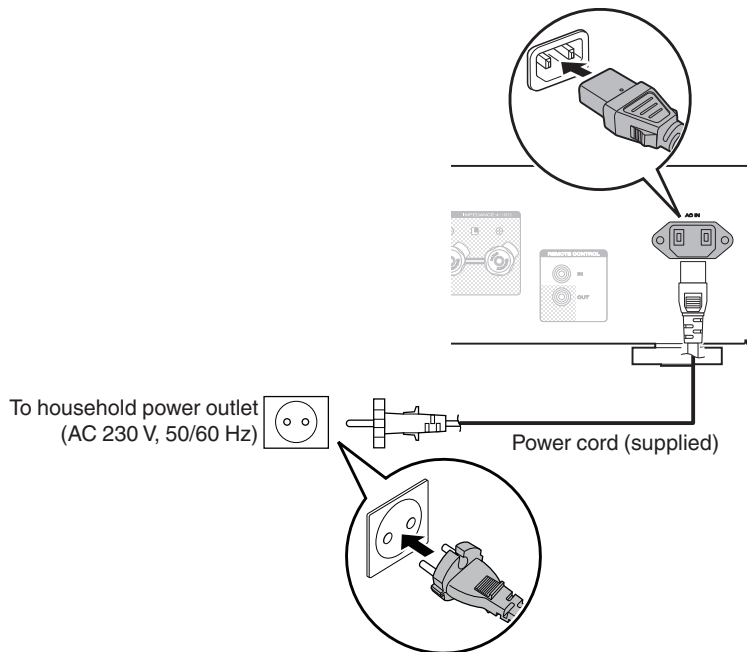

■ Contents

| | |
|--|----|
| Turning the power on | 27 |
| Turning speaker output on | 28 |
| Selecting the input source | 28 |
| Adjusting the volume | 28 |
| Turning off the sound temporarily (Muting) | 28 |
| Adjusting the tone | 28 |
| Playing CDs | 29 |
| Connecting and playing back from a computer (USB-DAC) | 30 |
| Connect and playback from a digital device (Coaxial/Optical) | 37 |
| Recording | 37 |



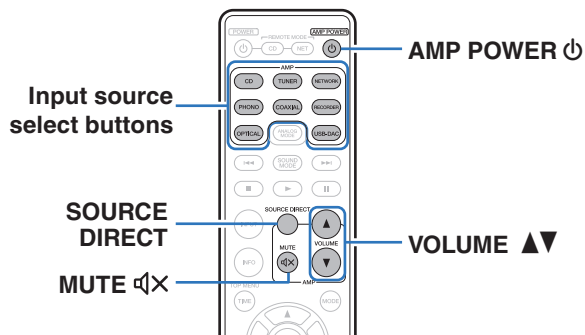

Turning the power on

1 Press **AMP POWER** on the main unit to turn the power on.

Input indicator for the selected source lights.



- Press AMP POWER to turn on power from standby mode.
- You can turn the INPUT SELECTOR when the unit is in standby mode to turn on the power.

NOTE

Turn VOLUME on the main unit to adjust the volume to the lowest level before turning on the power.

Turning the power off

1 Press **AMP POWER** on the main unit to turn the power off.

All lit indicators turn off.

Switching the power to standby

1 Press **AMP POWER** on the remote control.

The power indicator lights in red.

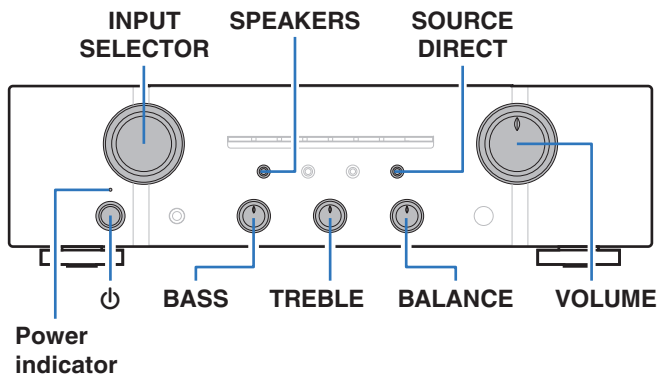

Turning speaker output on

1 Press **SPEAKERS** on the main unit.

The SPEAKERS indicator lights.



When using headphones, press SPEAKERS to turn off the indicator and turn audio output from the speaker terminals off.

Selecting the input source

1 Press the **input source select button** to be played back.

The indicator of the selected input source lights.



You can also select the input source by turning INPUT SELECTOR on the main unit.

Adjusting the volume

1 Press **VOLUME ▲▼** to adjust the volume.



You can also adjust the master volume by turning VOLUME on the main unit.

Turning off the sound temporarily (Muting)

1 Press **MUTE** .

The mute indicator lights.



- To cancel mute, press MUTE  again.
- You can also press MUTE on the main unit to turn off the sound temporarily.

Adjusting the tone

1 Press **SOURCE DIRECT** to turn off source direct mode.

The SOURCE DIRECT indicator turns off.

2 Turn the **BASS, TREBLE** and **BALANCE** to adjust the tone.





You can also press SOURCE DIRECT on the main unit to turn off source direct mode.



Playing CDs

This section uses playback from a CD as an example.

- 1 Press  on this unit to turn the power on.**
- 2 Press SPEAKER on this unit to turn on the speaker output.**
The SPEAKERS indicator lights.
- 3 Press the input source select button (CD) to switch the input source to “CD”.**
The “CD” input indicator lights.
- 4 Playback the CD.**
- 5 Press VOLUME   to adjust the volume.**

■ Playback in source direct mode

The signal does not pass through the tone adjustment circuitry (BASS, TREBLE and BALANCE), resulting in playback of a higher sound quality.

- 1 Press SOURCE DIRECT to turn on source direct mode.**
The SOURCE DIRECT indicator lights.

■ Playback in ANALOG MODE

If ANALOG MODE is turned on when playing back an analog input source (Phono, CD, NETWORK, TUNER, RECORDER), power to the digital input circuit is turned off. This prevents the analog signal circuit from being affected by noise generated by the digital control circuit, resulting in high quality audio playback.

- 1 Press ANALOG MODE to turn analog mode on.**
The ANALOG MODE indicator lights.



- A digital input source (COAXIAL, OPTICAL, USB-DAC) cannot be selected when ANALOG MODE is on. Also, if the input source switching button on the remote control unit is pressed to switch to a digital input source, the ANALOG MODE indicator on the unit flashes to indicate that you cannot switch to a digital input source.
- The input source automatically switches to CD if ANALOG MODE is turned on during playback of a digital input source (COAXIAL, OPTICAL, USB-DAC).
- Communication between this unit and the computer is disconnected if ANALOG MODE is turned on when a computer is connected to the USB-DAC input connector of this unit. If the unit cannot communicate with the computer after turning ANALOG MODE off again, disconnect and reconnect the USB cable or restart the audio player on the computer.
- When the analog mode is switched, the mute circuit is activated for about 4 seconds.



Connecting and playing back from a computer (USB-DAC)

You can enjoy high-quality audio playback from the D/A converter built in to this unit by inputting PCM signal or DSD signal music files into this unit from a computer via USB connection.

- Before USB connecting this unit to your computer, install the driver software in your computer.
- Drivers do not need to be installed for Mac OS.
- Also, you can use whichever commercially available or downloadable player software you like to playback files on your computer.

■ Computer (recommended system)

OS

- Windows® Vista, Windows 7 or Windows 8
- Mac OS X 10.6.3 or later

USB

- USB 2.0: USB High speed/USB Audio Class Ver.2.0

- DSD is a registered trademark.
- Microsoft, Windows Vista, Windows 7 and Windows 8 are either registered trademarks or trademarks of Microsoft Corporation in the United States and/or other countries.
- Apple, Macintosh and Mac OS are trademarks of Apple Inc., registered in the U.S. and other countries.

■ Installing the dedicated driver (Windows OS only)

□ Installing the driver software

- 1 Disconnect the USB cable between your PC and the unit.**
 - The driver software cannot be installed correctly if your PC is connected to the unit by a USB cable.
 - If the unit and your computer are connected by a USB cable and the computer is switched on before installation, disconnect the USB and restart the computer.
- 2 Download the dedicated driver from the “Download” section of the PM7005 page of the Marantz website onto your PC.**
- 3 Unzip the downloaded file, select the 32-bit or 64-bit exe file that matches your Windows operating system, and double-click the file.**



4 Install the driver.

- ① Select the language to use for the installation.
- ② Click “OK”.

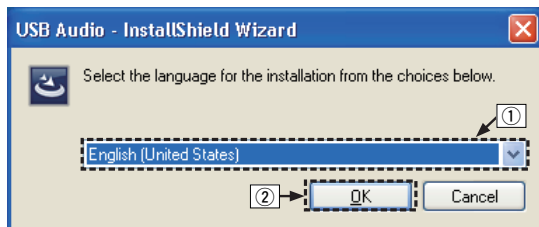

- ③ The wizard menu is displayed. Click “Next”.



- ④ Read the Software Licensing Agreement, and click “I accept the terms in the license agreement”.
- ⑤ Click “Next”.



- ⑥ Click “Install” on the installation start dialog.
 - The installation starts. Do not perform any operation on the PC until the installation is completed.

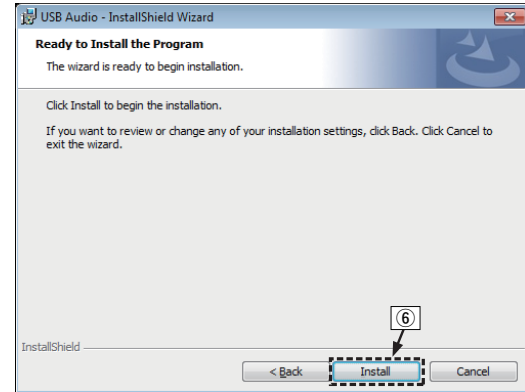

- ⑦ In the Windows security dialog, select “Always trust software from “DandM Holdings Inc.””.
- ⑧ Click “Install”.



- ⑨ When the installation is completed, click “Finish”.

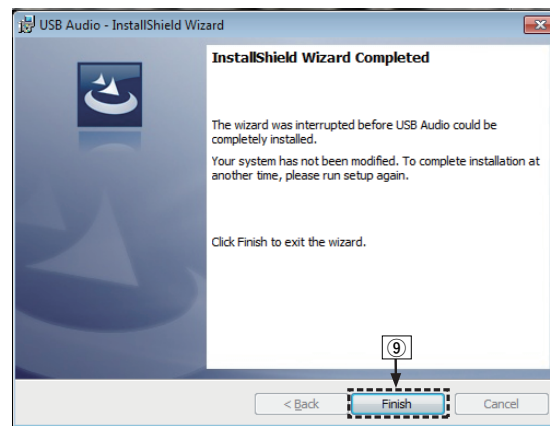

5 With the unit power off, connect the unit and PC using a USB cable (sold separately).

- For details on connections, see “Connecting a PC or Mac” (📖 p. 23).



6 Press POWER .

- When the unit power is turned on, the PC automatically finds and connects to the unit.

7 Press the input source select button (USB-DAC) to switch the input source to “USB-DAC”.

8 Checking the installed driver.

- ① Click the “Start” button and click “Control Panel” on the PC.
 - The control panel setting list is displayed.
- ② Click the “Sound” icon.
 - The sound menu window is displayed.
- ③ Check that there is a checkmark next to “Default Device” under in “Digital Audio Interface” of the “Playback” tab.
 - When there is a checkmark for a different device, click “Marantz USB Audio” and “Set Default”.

9 Checking audio output.

Outputs a TEST signal from the PC and checks the audio output from the USB-DAC function.

- ① Select “Digital Audio Interface” and click “Properties”.
 - The Digital Audio Interface Properties window is displayed.

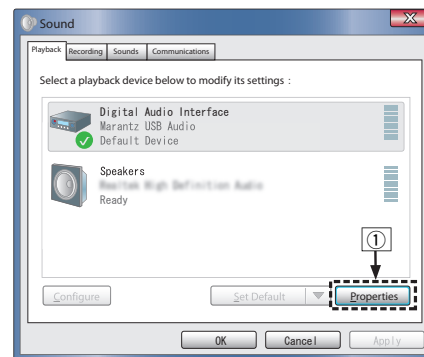

- ② Click the “Advanced” tab.
 - ③ Select the sampling rate and bit rate to be applied to the D/A converter.
 - It is recommended that “2 channel, 24 bit, 192000 Hz (Studio Quality)” is selected.
 - ④ Click “Apply”.
 - ⑤ Click “Test”.
- Check that audio from this unit is output from the PC.

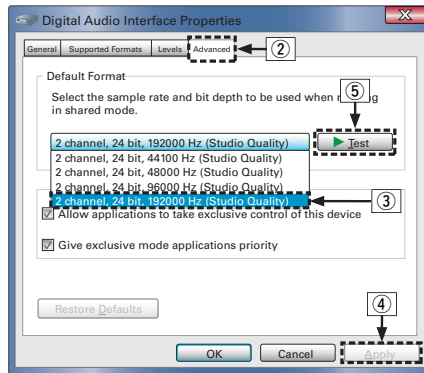
**NOTE**

- The dedicated driver must be installed in the PC before this unit is connected to a PC. Operation will not occur correctly if connected to the PC before the dedicated driver has been installed.
- Operation may fail in some PC hardware and software configurations.



■ Playback

Install the desired player software on your computer beforehand.
Use the rear panel USB-DAC port to connect this unit to a computer.
For the connection procedure, refer to the “Connecting a PC or Mac” (👉 p. 23) section.

1 Press the input source select button (USB-DAC) to switch the input source to “USB-DAC”.

The “USB-DAC” input indicator lights.

2 Start playback on the computer’s player software.

3 Press VOLUME ▲▼ to adjust the volume.

NOTE

The USB-DAC input indicator flashes if this unit cannot detect the sampling frequency of the input signal.

■ Files that can be played back

See “D/A converter” (👉 p. 47).

NOTE

- Perform operations such as playback and pause on the computer. At this time, you cannot perform operations with buttons on this unit or the remote control.
- You can also control the volume and equalizer on the computer. Enjoy playing music at the desired volume.
- When this unit is functioning as a D/A converter, sound is not output from the computer’s speakers.
- If the computer is disconnected from this unit while the computer music playback software is running, the playback software may freeze. Always exit the playback software before disconnecting the computer.
- When an abnormality occurs on the computer, disconnect the USB cable and restart the computer.
- Use a cable that is 3 m or less to connect to the computer.



Connect and playback from a digital device (Coaxial/Optical)

- 1 Connect digital device to this unit.** (🔧 p. 22)
- 2 Press the input source select button (COAXIAL or OPTICAL) to switch the input source to “COAXIAL” or “OPTICAL”.**
- 3 Start playback of the digital device connected to this unit.**

The COAXIAL or OPTICAL input indicator flashes if this unit cannot detect the sampling frequency of the input signal.
- 4 Press VOLUME ▲▼ to adjust the volume.**

■ Files that can be played back

See “D/A converter” (🔧 p. 47).

NOTE

- Do not input non-PCM signals, such as Dolby Digital, and DTS. This causes noise and could damage the speakers.
- If the sampling frequency switches, such as from A mode to B mode in a CS broadcast, muting may operate for 1 – 2 seconds, cutting the sound.

Recording

Audio signals input into this unit can be output to an external recording device. When recording audio from a playback device connected to this unit, audio can be recorded with the playback device still connected to this unit.

- 1 Press  on this unit to turn the power on.**
- 2 Press the input source select button to switch to the input source from which you want to record.**

The indicator of the selected input source lights.
- 3 Recording starts.**
 - For information on operations, see the owner’s manual of the recording device.



Setting the Auto Standby mode

You can set the unit to automatically switch to standby mode if the unit is not operated for 30 minutes when there is no audio input (Auto Standby mode).

Auto Standby mode is set to on by default.

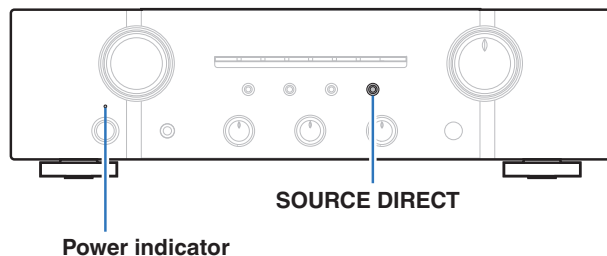

Turning Auto Standby mode off

- 1 Press and hold SOURCE DIRECT for more than 5 seconds to turn the Auto Standby mode off.**
The power indicator flashes once.

Turning Auto Standby mode on

- 1 Press and hold SOURCE DIRECT for more than 5 seconds to turn the Auto Standby mode on.**
The power indicator flashes three times.



■ Contents

Tips

| | |
|---|----|
| I want to adjust the tone myself | 40 |
| I want sound playback that is faithful to the original sound | 40 |
| I want to operate a Marantz CD player or network audio player using the remote control of this unit | 40 |
| I want to enjoy higher sound quality from the analog input source | 40 |

Troubleshooting

| | |
|--|----|
| Power does not turn on / Power is turned off | 42 |
| Operations cannot be performed through the remote control unit | 43 |
| No sound comes out | 44 |
| Desired sound does not come out | 44 |
| Sound is interrupted or noise occurs | 45 |
| PC or Mac files cannot be played back | 46 |



Tips

I want to adjust the tone myself

- Use the BASS, TREBLE and BALANCE knobs to adjust the sound as desired. (👉 p. 28)

I want sound playback that is faithful to the original sound

- Set the Source Direct mode on. (👉 p. 29)

I want to operate a Marantz CD player or network audio player using the remote control of this unit

- Switch the remote control operating mode. (👉 p. 13, 15)
- Also refer to the CD player or network audio player instruction manuals.

I want to enjoy higher sound quality from the analog input source

- Set the Analog mode on. (👉 p. 29)



Troubleshooting

1. **Are the connections correct?**
2. **Is the set being operated as described in the owner's manual?**
3. **Are the other devices operating properly?**

If this unit does not operate properly, check the corresponding symptoms in this section.

If none of the symptoms are applicable, consult your dealer as it could be due to a fault in this unit. In this case, disconnect the power immediately and contact the store where you purchased this unit.



■ Power does not turn on / Power is turned off

| Symptom | Cause / Solution | Page |
|--|--|-----------|
| Power is not turned on. | <ul style="list-style-type: none"> Check whether the power plug is correctly inserted into the power outlet. | <u>25</u> |
| Power automatically turns off. | <ul style="list-style-type: none"> The Auto Standby mode is set. The Auto Standby mode switches the unit to standby mode when the unit is not operated for approximately 30 minutes. To disable the Auto Standby mode, press and hold the SOURCE DIRECT button on the unit for more than 5 seconds when the Auto Standby mode is enabled. | <u>38</u> |
| Power turns off and the power indicator flashes in red approx. every 0.5 seconds. | <ul style="list-style-type: none"> The protection circuit has been activated due to a rise in temperature within this unit. Turn the power off, wait about an hour until this unit cools down sufficiently, and then turn the power on again. | <u>47</u> |
| | <ul style="list-style-type: none"> Please re-install this unit in a place having good ventilation. | — |
| Power turns off and the power indicator flashes in red approx. every 0.25 seconds. | <ul style="list-style-type: none"> Check the speaker connections. The protection circuit may have been activated because speaker cable core wires came in contact with each other or a core wire was disconnected from the connector and came in contact with the rear panel of this unit. After unplugging the power cord, take corrective action such as firmly re-twisting the core wire or taking care of the connector, and then reconnect the wire. | <u>18</u> |
| | <ul style="list-style-type: none"> Turn down the volume and turn on the power again. | <u>27</u> |
| When the power is turned on, the power indicator flashes red approx. every 0.25 seconds. | <ul style="list-style-type: none"> This unit's amplifier circuit has failed. Turn off the power and please contact the Marantz service adviser. | — |



■ Operations cannot be performed through the remote control unit

| Symptom | Cause / Solution | Page |
|---|--|----------|
| Operations cannot be performed through the remote control unit. | • Batteries are worn out. Replace with new batteries. | <u>4</u> |
| | • Operate the remote control unit within a distance of about 7 m from this unit and at an angle of within 30°. | <u>4</u> |
| | • Remove any obstacle between this unit and the remote control unit. | — |
| | • Insert the batteries in the proper direction, checking the ⊕ and ⊖ marks. | <u>4</u> |
| | • The set's remote control sensor is exposed to strong light (direct sunlight, inverter type fluorescent bulb light, etc.). Move the set to a place in which the remote control sensor will not be exposed to strong light. | — |
| | • When using a 3D video device, the remote control unit of this unit may not function due to effects of infrared communications between units (such as TV and glasses for 3D viewing). In this case, adjust the direction of units with the 3D communications function and their distance to ensure they do not affect operations from the remote control unit of this unit. | — |



■ No sound comes out

| Symptom | Cause / Solution | Page |
|---------------------------------|---|-----------|
| No sound comes out of speakers. | • Check the connections for all devices. | <u>17</u> |
| | • Insert connection cables all the way in. | — |
| | • Check that input connectors and output connectors are not reversely connected. | — |
| | • Check cables for damage. | — |
| | • Check that speaker cables are properly connected. Check that cable core wires come in contact with the metal part on speaker terminals. | <u>18</u> |
| | • Securely tighten the speaker terminals. Check speaker terminals for looseness. | <u>18</u> |
| | • Check that the proper input source is selected. | <u>28</u> |
| | • Adjust the master volume. | <u>28</u> |
| • Cancel the muting mode. | <u>28</u> | |

■ Desired sound does not come out

| Symptom | Cause / Solution | Page |
|---|---|-----------|
| No sound comes out of a specific speaker. | • Check that speaker cables are properly connected. | <u>18</u> |
| | • Adjust the BALANCE control knob. | <u>28</u> |
| The left and right of stereo sound is reversed. | • Check whether the left and right speakers are connected to the correct speaker terminals. | <u>18</u> |



■ Sound is interrupted or noise occurs

| Symptom | Cause / Solution | Page |
|--|--|-----------|
| When playing a record, the sound is distorted. | • Adjust to a proper needle pressure. | — |
| | • Check the tip of the needle. | — |
| | • Replace the cartridge. | — |
| When playing a record, a humming noise comes out of the speakers. | • Check that the turntable is connected correctly. | <u>20</u> |
| | • If there is a TV or AV device near the turntable, such devices may affect the playback sound. Install the turntable in a location as far away as possible from the TV or other AV devices. | — |
| When playing a record, a humming noise comes out of the speakers when the volume is high. (Howling phenomenon) | • Install the turntable and speakers as far from each other as possible. | <u>20</u> |
| | • The vibrations from the speakers are being transmitted to the player through the floor. Use cushions, etc., to absorb the speakers' vibrations. | — |
| Sound is interrupted during playback of tracks saved on a computer. | • Do not start applications other than the player software while playing music on your computer. | — |



■ PC or Mac files cannot be played back

| Symptom | Cause / Solution | Page |
|---|---|--------------------|
| The PC or Mac cannot recognize this unit. | • Check the OS of the PC or Mac connected to this unit. | 30 |
| | • A specialized driver needs to be installed when using a Windows PC. | 30 |
| The input indicator of USB-DAC blinks. | • The input indicator of USB-DAC blinks when audio signals that are not supported by this unit are input. Check the settings on your computer or player software. | — |
| | • If the computer you use is "Mac OS", please check if the "USB High Speed Audio" format is set below "192000.0 Hz" using the "Audio MIDI Setup". | — |



D/A converter

■ Specifications of supported files

□ USB-DAC

| | Sampling frequency | Bit length |
|------------------------|--------------------------------------|------------|
| DSD (2-channel) | 2.8 MHz/5.6 MHz | 1 bit |
| Linear PCM (2-channel) | 32/44.1/48/88.2/96/ 176.4/192 kHz | 16/24 bits |

□ Coaxial/Optical

| | Sampling frequency | Bit length |
|------------------------|---|------------|
| Linear PCM (2-channel) | 32/44.1/48/64/88.2/96/ 176.4/192 kHz | 16/24 bits |

Explanation of terms

Speaker impedance

This is an AC resistance value, indicated in Ω (Ohms).
Greater power can be obtained when this value is smaller.

Source direct

Playback with higher fidelity to the source becomes possible, as input audio signals are output by bypassing the audio quality-control circuits (BASS/TREBLE/BALANCE).

Protection circuit

This is a function to prevent damage to devices within the power supply when an abnormality such as an overload, excess voltage occurs or over temperature for any reason.

If a malfunction occurs in this unit, the power indicator blinks red and the unit switches to standby mode.



Specifications

- **RMS Power output (20 Hz – 20 kHz simultaneous drive of both channels) :**
 - 60 W x 2 (8 Ω /ohms load)
 - 80 W x 2 (4 Ω /ohms load)
- **Total harmonic distortion (20 Hz – 20 kHz simultaneous drive of both channels, 8 Ω /ohms load) :** 0.02 %
- **Output band width (8 Ω /ohms load, 0.06 %) :** 5 Hz – 60 kHz
- **Frequency response (CD, 1 W, 8 Ω /ohms load) :** 5 Hz – 100 kHz \pm 3 dB
- **Dumping factor (8 Ω /ohms load, 40 Hz – 20 kHz) :** 100
- **Input sensitivity/Input impedance**
 - PHONO (MM) :** 2.0 mV/47 k Ω /kohms
 - CD, TUNER, NETWORK, RECORDER :** 200 mV/20 k Ω /kohms
- **Maximum allowable PHONO input level (1 kHz) MM :** 100 mV
- **RIAA deviation (20 Hz – 20 kHz) :** \pm 0.5 dB
- **S/N (IHF-A, 8 Ω /ohms load)**
 - PHONO (MM) :** 85 dB (5 mV input, 1 W output)
 - CD, TUNER, NETWORK, RECORDER :** 104 dB (2 V input, Rated output)
- **Tone Control**
 - BASS (50 Hz) :** \pm 10 dB
 - TREBLE (15 kHz) :** \pm 10 dB
- **Power requirement :** AC 230 V, 50/60 Hz
- **Power consumption (EN60065) :** 170 W
- **Power consumption in standby mode :** 0.2 W



- **Digital input signal format**

Format:

Digital audio interface (Linear PCM)

Coaxial input:

0.5 Vp-p / 75 Ω /ohms

Optical input:

More than -27 dBm

Optical wavelength:

660 nm

For the purpose of improvement, the specifications and design are subject to change without notice.



■ Dimensions (Unit : mm)

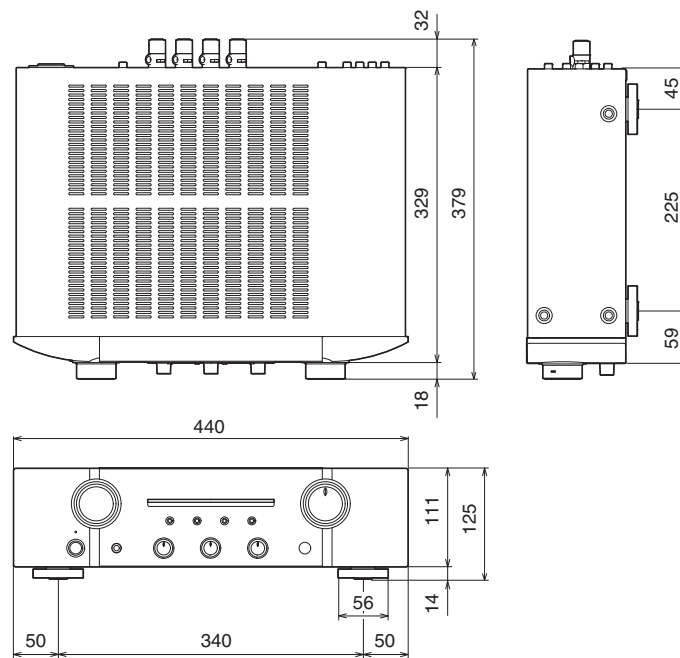

■ Weight: 10.0 kg



Index

| | | | | | |
|---|----|----------------------------------|--------|--|----|
| A | | D | | T | |
| Adjusting the tone | 28 | D/A Converter | 30 | Tips | 40 |
| Adjusting the volume | 28 | I | | TREBLE | 28 |
| Auto Standby mode | 38 | Inserting the batteries | 4 | Troubleshooting | 41 |
| B | | Install the driver | 30 | Turning off the sound temporarily (Muting) | 28 |
| BALANCE | 28 | P | | U | |
| BASS | 28 | Protection circuit | 47 | USB-DAC | 30 |
| C | | R | | | |
| Cables | 17 | Remote control | 24 | | |
| Connecting a digital audio device | 22 | Remote control unit | 12 | | |
| Connecting a PC or Mac | 23 | S | | | |
| Connecting a playback device | 20 | Selecting the input source | 28 | | |
| Connecting a recording device | 21 | Source direct | 29, 47 | | |
| Connecting speakers | 18 | Speaker impedance | 47 | | |
| Connecting a power cord | 25 | | | | |



www.marantz.com

You can find your nearest authorized distributor or dealer on our website.

marantz[®] is a registered trademark.

D&M Holdings Inc.
3520 10340 00AM